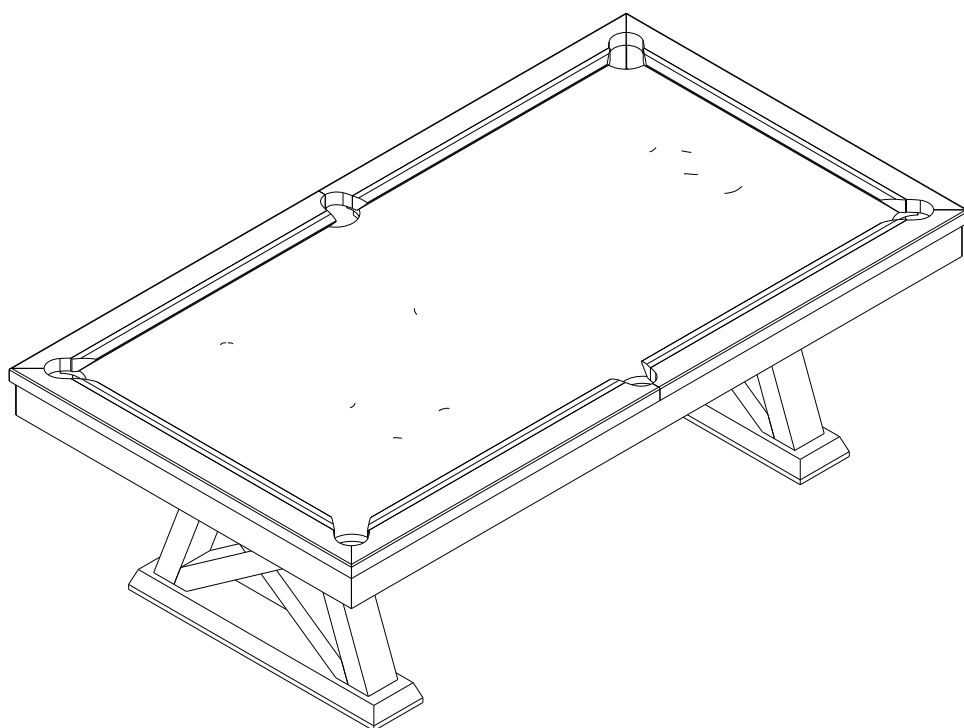


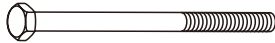
















8' LAREDO







LAREDO ASSEMBLY INSTRUCTIONS


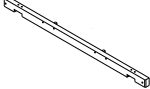
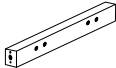




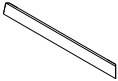


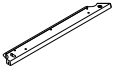



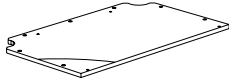
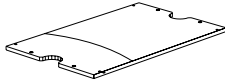
REPLACEMENT PARTS LIST (HARDWARE)

PACKAGE	ITEM#	SAMPLE	DESCRIPTION	QTY.
LEG	H1		HEX HEAD CROSS BOLT 3/8" X 3-1/8"(M10X80mm)	8
	H2		FLAT WASHER 3/8" I.D.	8
CABINET/BEAM/BLOCK	H3		HEX BOLT 3/8" X 5-1/8"(M10X130mm)	4
	H4		FLAT WASHER 3/8" I.D.	4
	H5		NUT 3/8" I.D.	4
	H6		HEX HEAD CROSS BOLT 5/16" X 2"(M8X50mm)	4
	H7		FLAT WASHER 5/16" I.D.	4
	H8		HEX HEAD CROSS BOLT 5/16" X 3-1/8"(M8X80mm)	16
	H9		FLAT WASHER 5/16" I.D.	16
RAIL/POCKET/SLATE	H10		FLAT HEAD SCREW 1/4" X 2-3/4"(M6X70mm)	12
	H11		STUD BOLT 5/16" X 5-1/2"(M8X140mm)	2
	H12		STUD BOLT 5/16" X 3-1/2"(M8X88mm)	4
	H13		FLAT WASHER 5/16" I.D.	12
	H14		HEX NUT 5/16" I.D.	12
	H15		HEX HEAD CROSS BOLT 5/16" X 1"(M8X25mm)	16
	H16		FLAT WASHER 5/16" I.D.	16
	H17		HEX HEAD CROSS BOLT 5/16" X 1-7/16"(M8X36mm)	12

REPLACEMENT PARTS LIST (HARDWARE)

PACKAGE	ITEM#	SAMPLE	DESCRIPTION	QTY.
RAIL/POCKET/SLATE	H18		FLAT WASHER 5/16" I.D.	12
	H19		HEX HEAD CROSS BOLT 3/8" X 2-3/8"(M10X60mm)	18
	H20		DOME WASHER 3/8" I.D.	18
	H21		FLAT HEAD SCREW 5# X 1/2"(M3X12mm)	24

REPLACEMENT PARTS LIST

PACKAGE	ITEM#	SAMPLE	DESCRIPTION	QTY.
LEG	1		LEG	2
CABINET/APRON	2		SIDE CABINET	2
	3		END CABINET	2
	4		CROSS BEAM	2
	5		LONG WOODEN BLOCK	4
	6		SHORT WOODEN BLOCK	4
	7		SIDE APRON	2
	8		END APRON	2
	9		APRON JOINT CORNER BLOCK	4
TOP RAIL	10		TOP RAIL LEFT SIDE	2
	11		TOP RAIL RIGHT SIDE	2
	12		TOP RAIL END	2
POCKET	13		SIDE POCKET	2
	14		CORNER POCKET	4
SLATE	15		SLATE (LEFT)	1
	16		SLATE (CENTER)	1

REPLACEMENT PARTS LIST

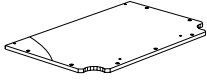


PACKAGE	ITEM#	SAMPLE	DESCRIPTION	QTY.
	17		SLATE (RIGHT)	1
	18		CLOTH	1
	19		WOOD JOINT	12

FIG.1

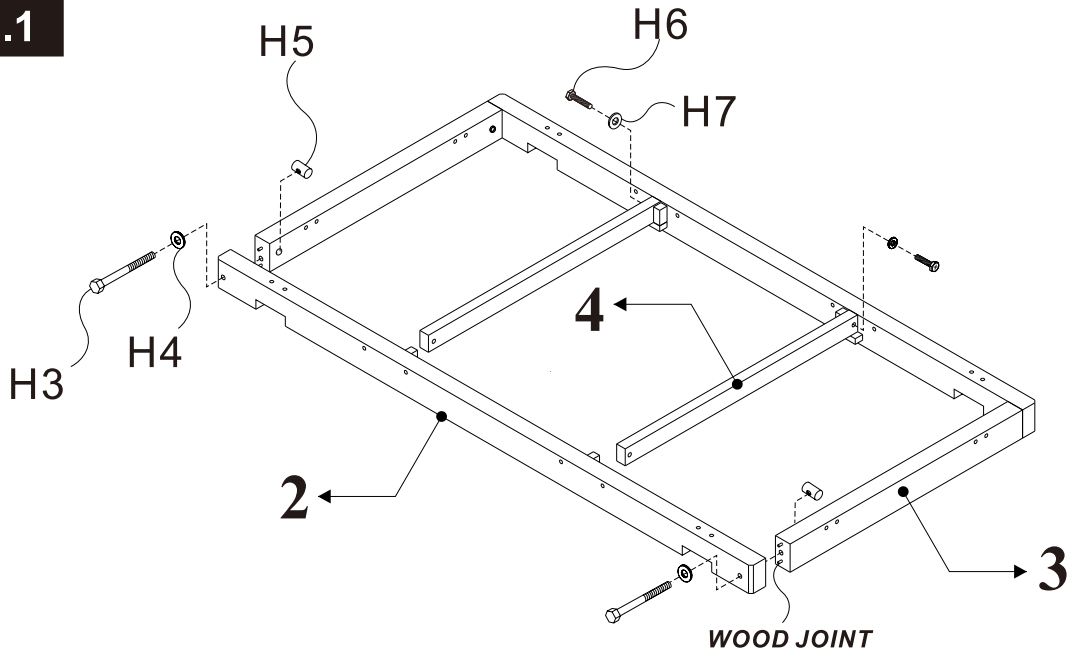


FIG.2

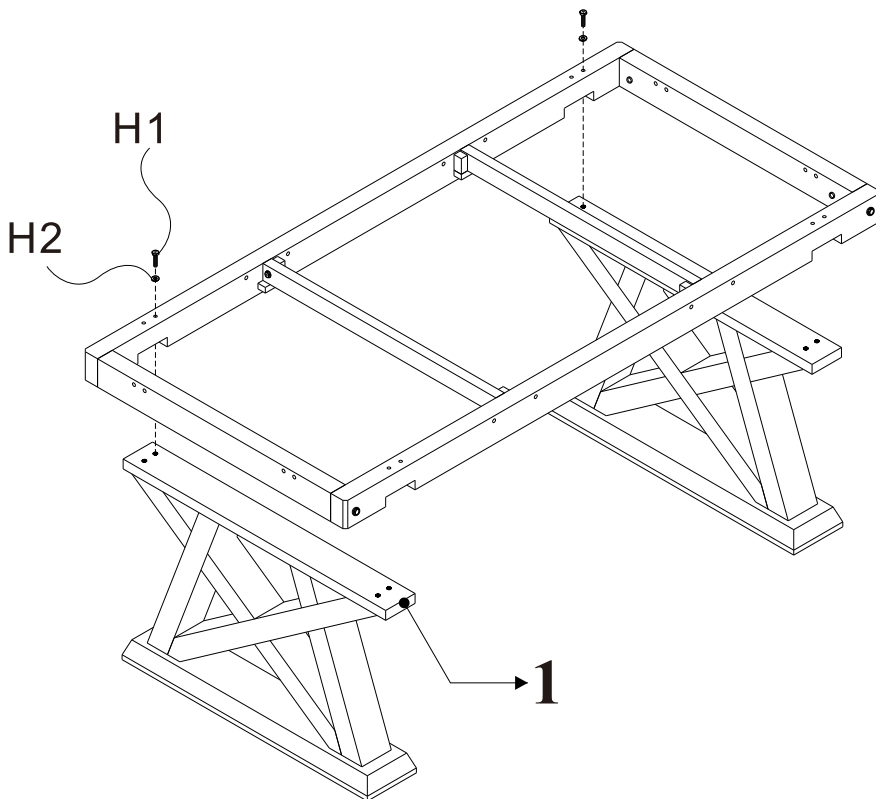


FIG.3

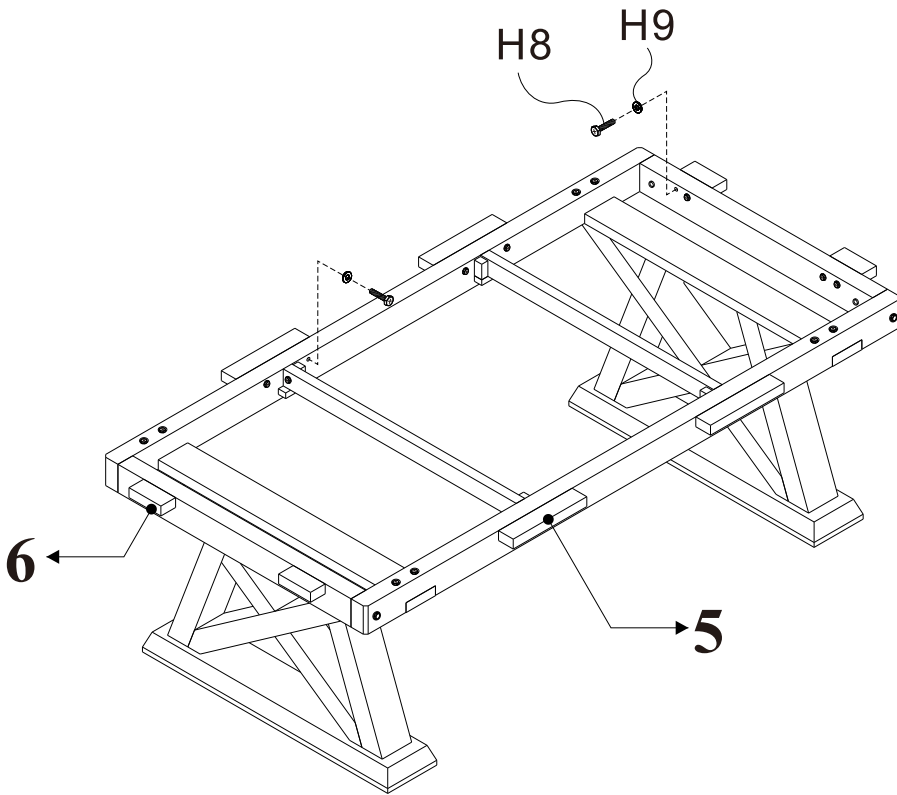


FIG.4

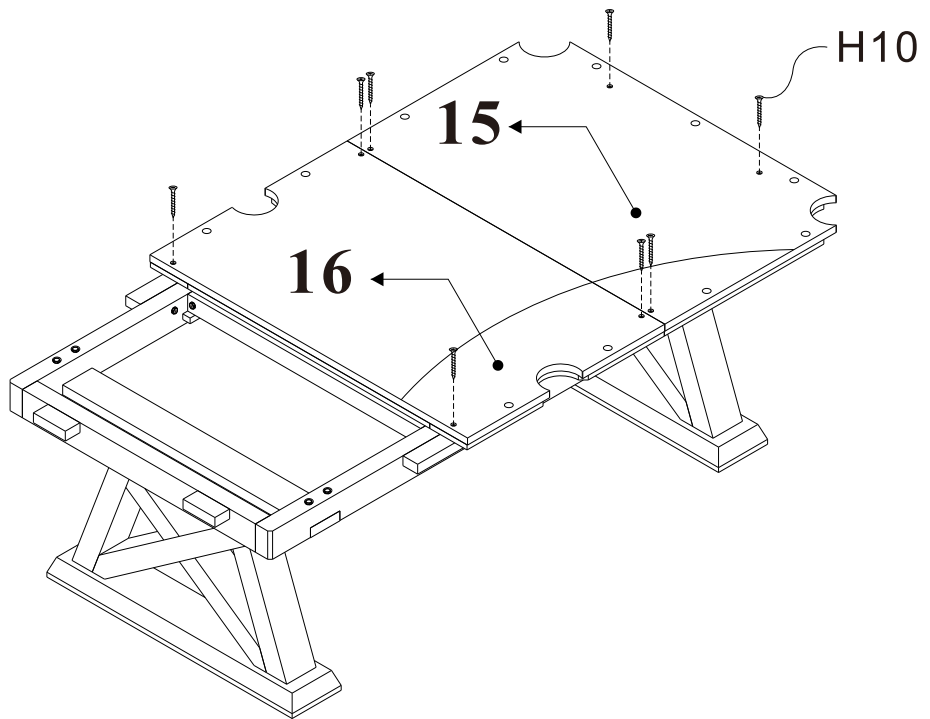


FIG.5

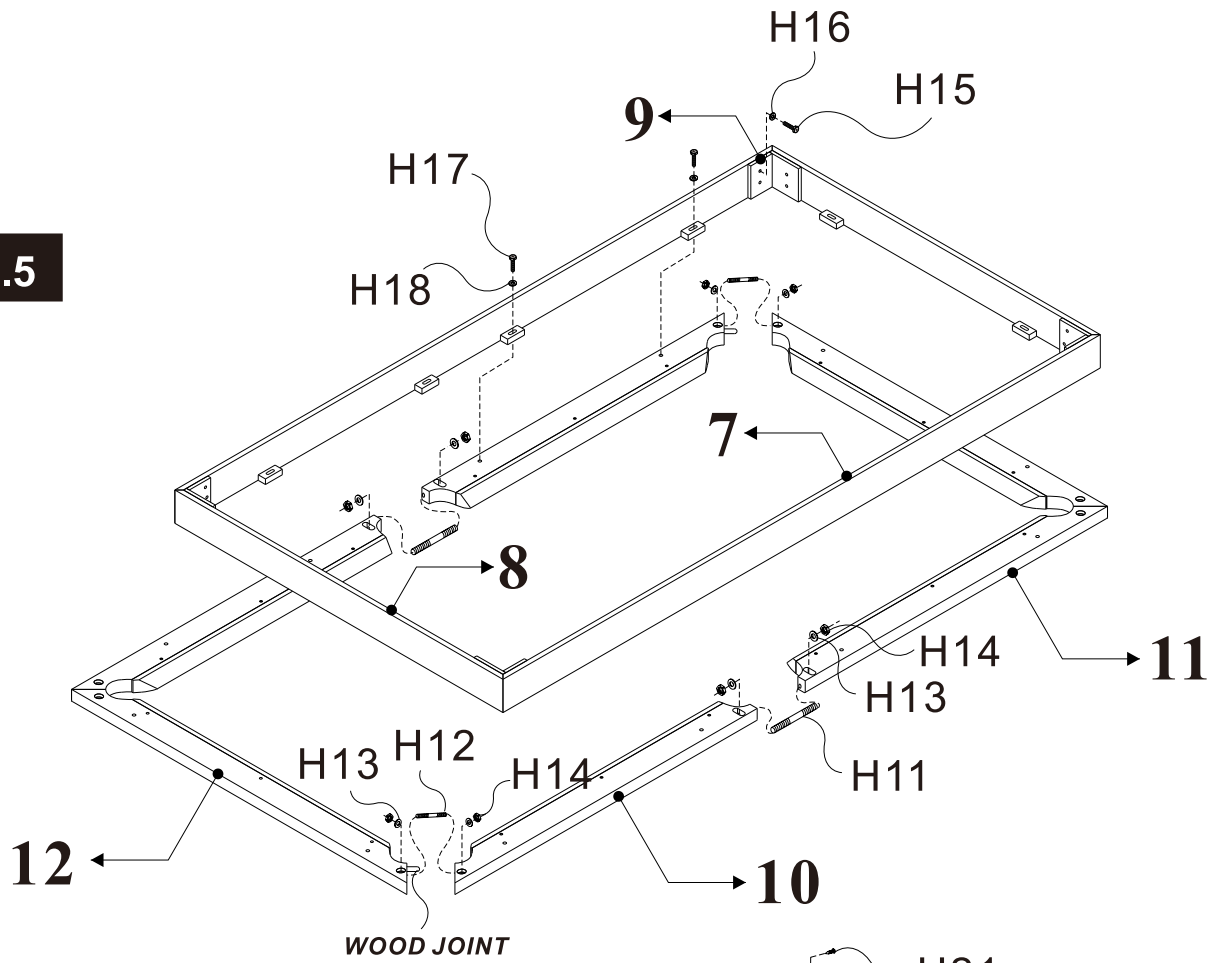
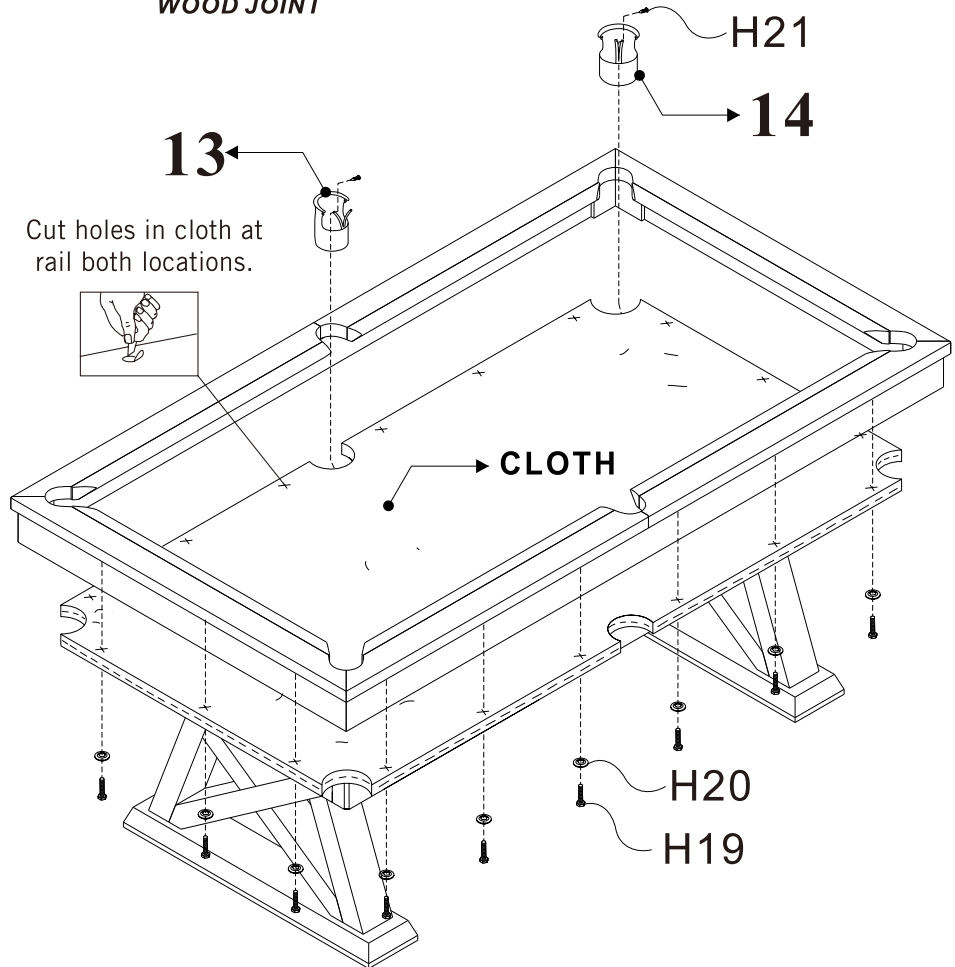


FIG.6



Finish

