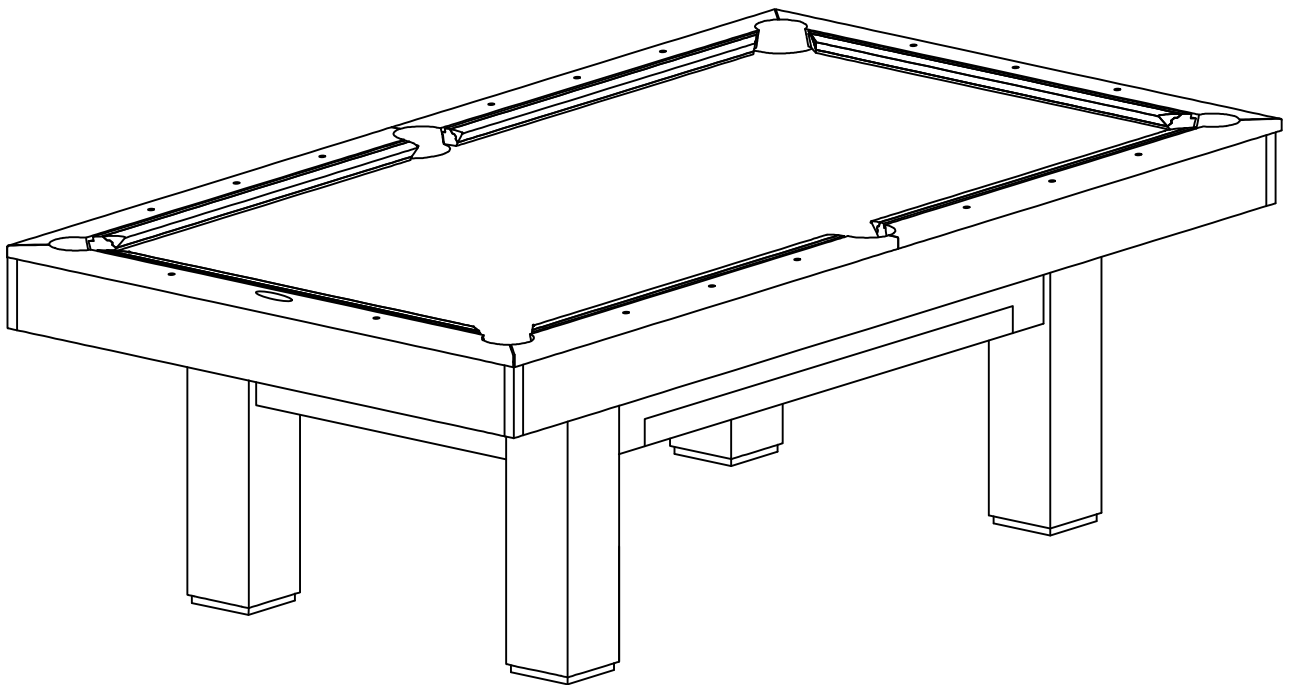


IMP 29-840L  
IMP 29-840-P/B  
IMP 29-840-P/H

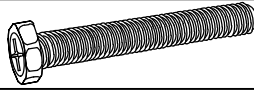
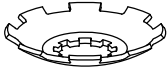
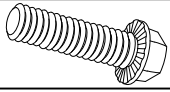


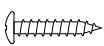
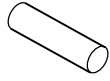

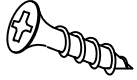
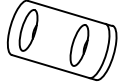
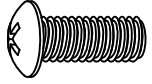


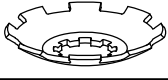
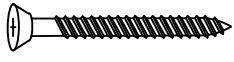







IMP 29-840D  
IMP 29-840-R/B

# 7' BROOKLINE



## BROOKLINE TABLE ASSEMBLY INSTRUCTIONS

# REPLACEMENT PARTS LIST (HARDWARE)

Package	Item #	Sample	Description	Qty
LEG/PANEL	A		BOLT Ø3/8" X 2 1/4"	16
	B		DOME WASHER Ø3/8"	16
	C		FLANGE BOLT Ø1/4" X 2"	14
	D		WASHER Ø1/4" x Ø5/8" X T3/32"	18
	E		SCREW Ø1/4" x 2-1/2"	4
	F		SCREW #8 x 5/8"	16
	G		Dowel Ø10x30	8
RAIL/BLIND	D		WASHER Ø1/4" x Ø5/8" X T3/32"	24
	H		SCREW #8 x 3/4"	8
	I		CONNECTOR PIN	4
	J		BOLT Ø1/4" x 5/8"	24
	K		IRON 5-7/8" x 1-1/2" x1-1/2"	4
	L		SCREW #8 x 1 1/4"	40
RAIL/POKET/SLATE	B		DOME WASHER Ø3/8"	18
	E		SCREW Ø1/4" x 2-1/2"	12
	M		WASHER Ø3/8"	18
	N		BOLT Ø3/8"xL3"	18
	O		NUT Ø3/8"	18
	P		CORNER POCKET	4
	Q		CENTER POCKET	2
	R		METAL BEAM 1 3/8" x 1 3/8" x 3/4"	4
	S		GLUE	1

# REPLACEMENT PARTS LIST (HARDWARE)


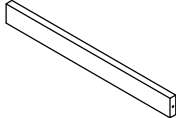
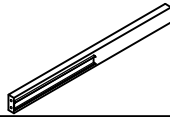
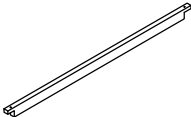
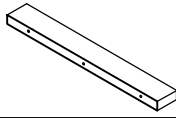
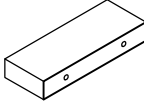
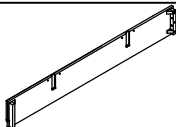
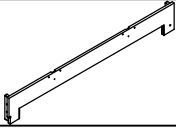
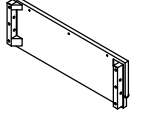
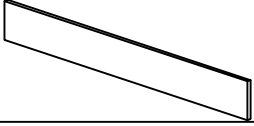

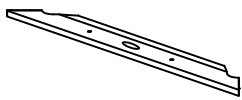
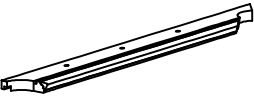
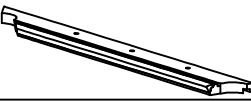
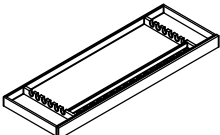
Package	Item #	Sample	Description	Qty
LEG	1		Leg	4
PANEL	2		Center beam	2
	3		Drawer beam	2
	4		Block drawer beam	1
	5		End wooden block	2
	6		Side wooden block	4
	7		Side panel	1
	8		Side panel drawer	1
	9		End panel	2
	Blind	10		End Blind
11			Side Blind	2
Rail	12		End Rail	2
	13		Rail left side	2
	14		Rail right side	2
Drawer	15		Drawer	1

Fig.1

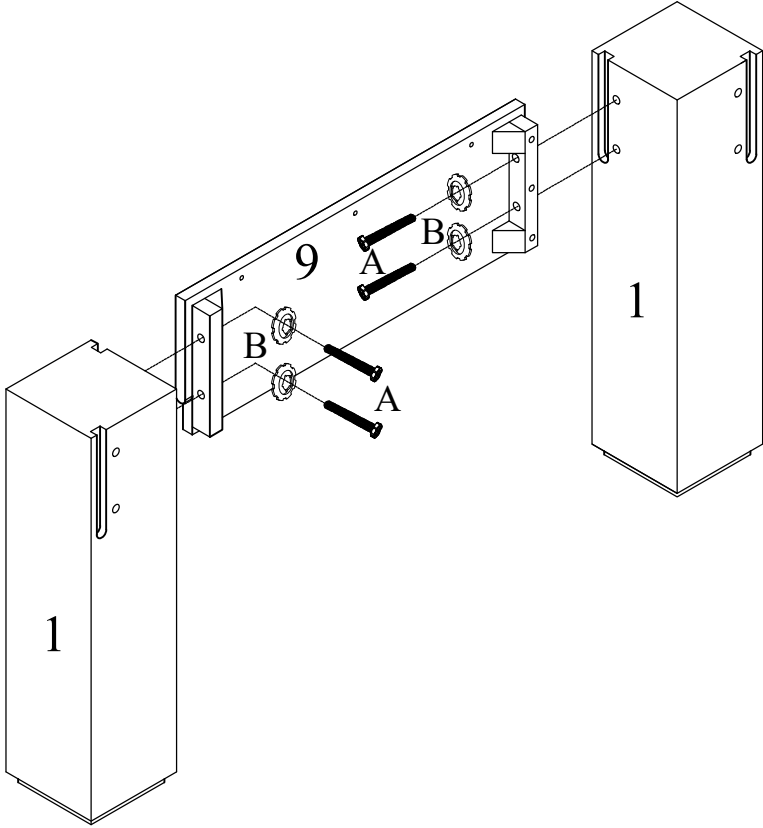


Fig.2 :Glue the wood dowels

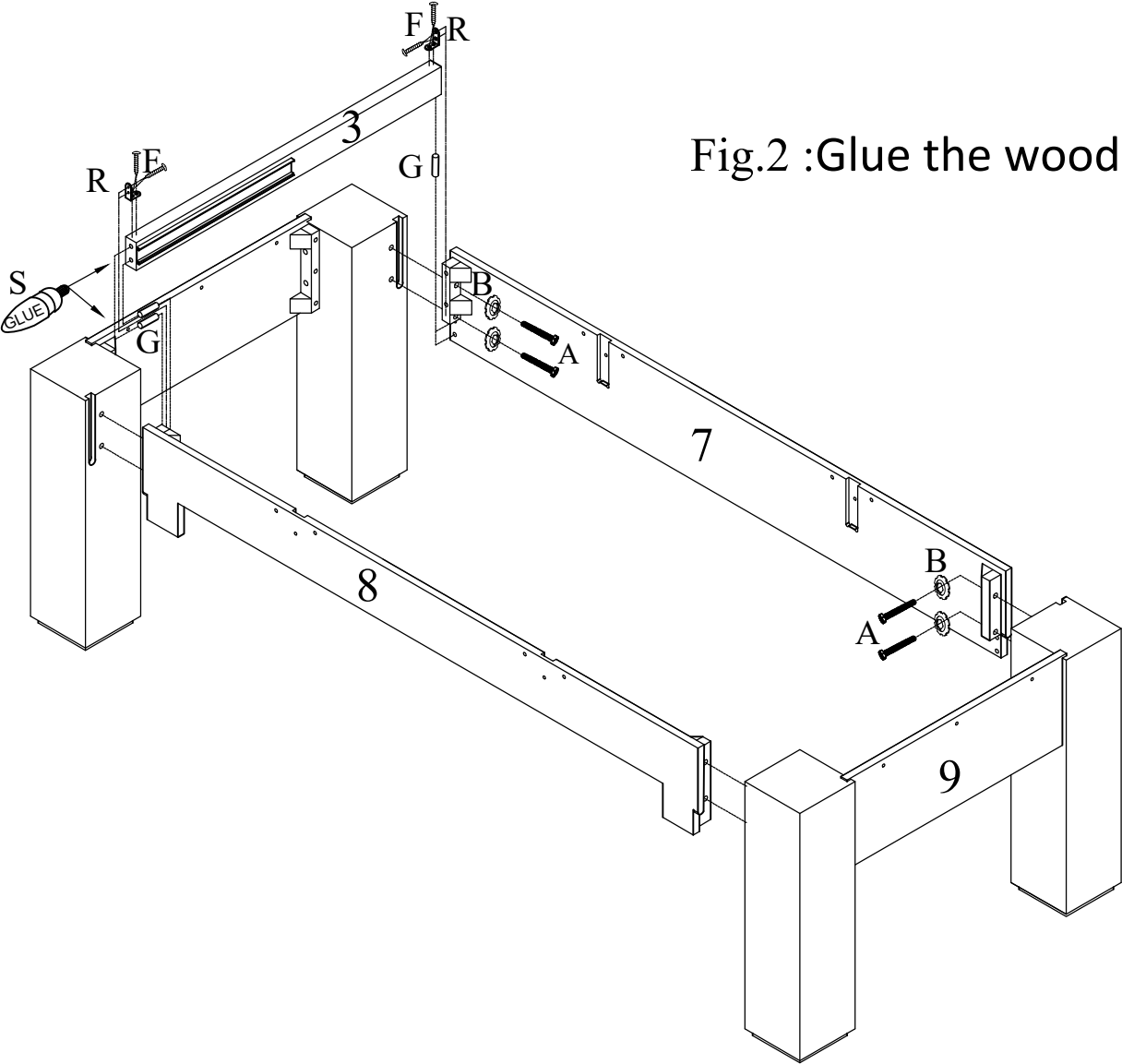


Fig.3

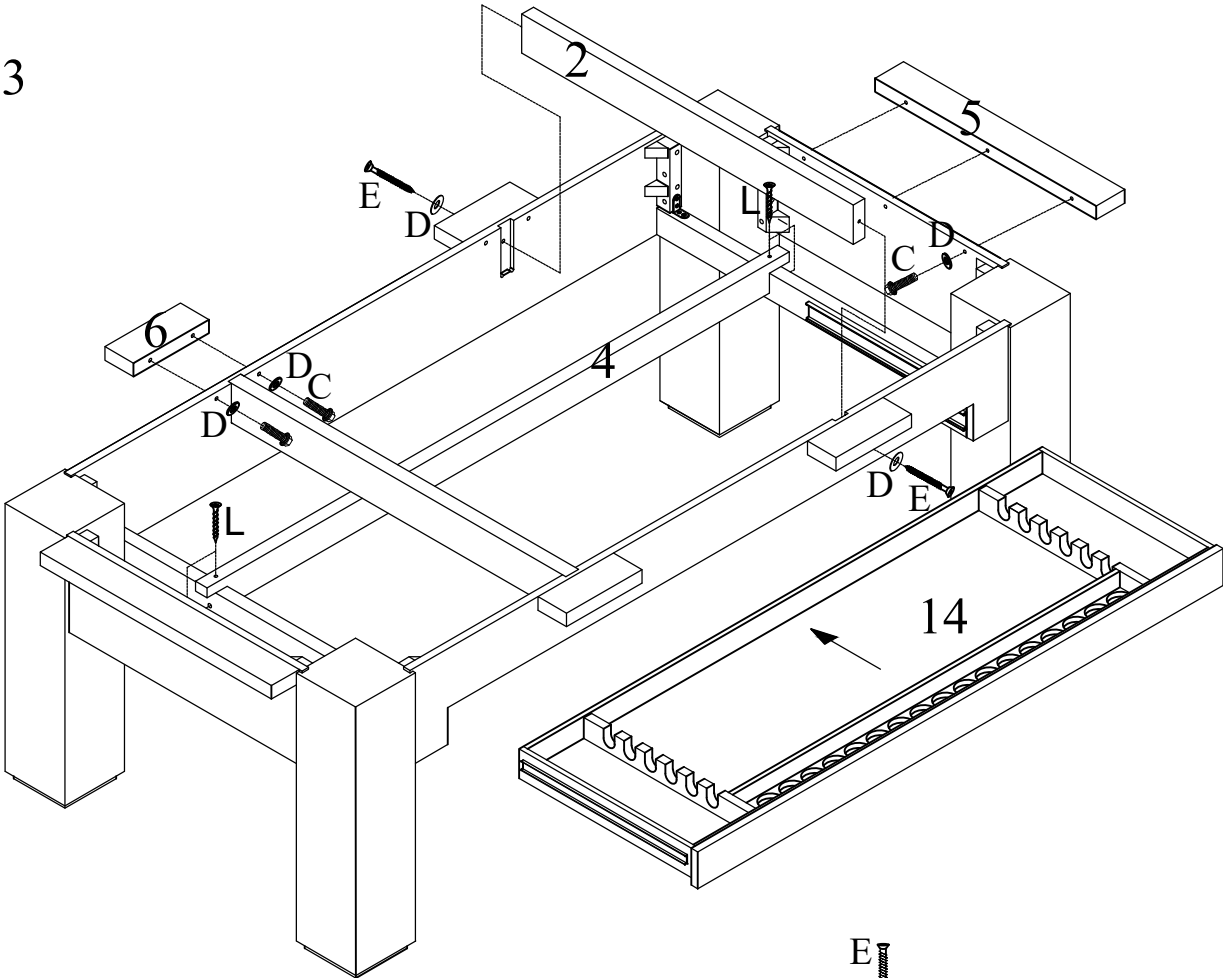


Fig.4

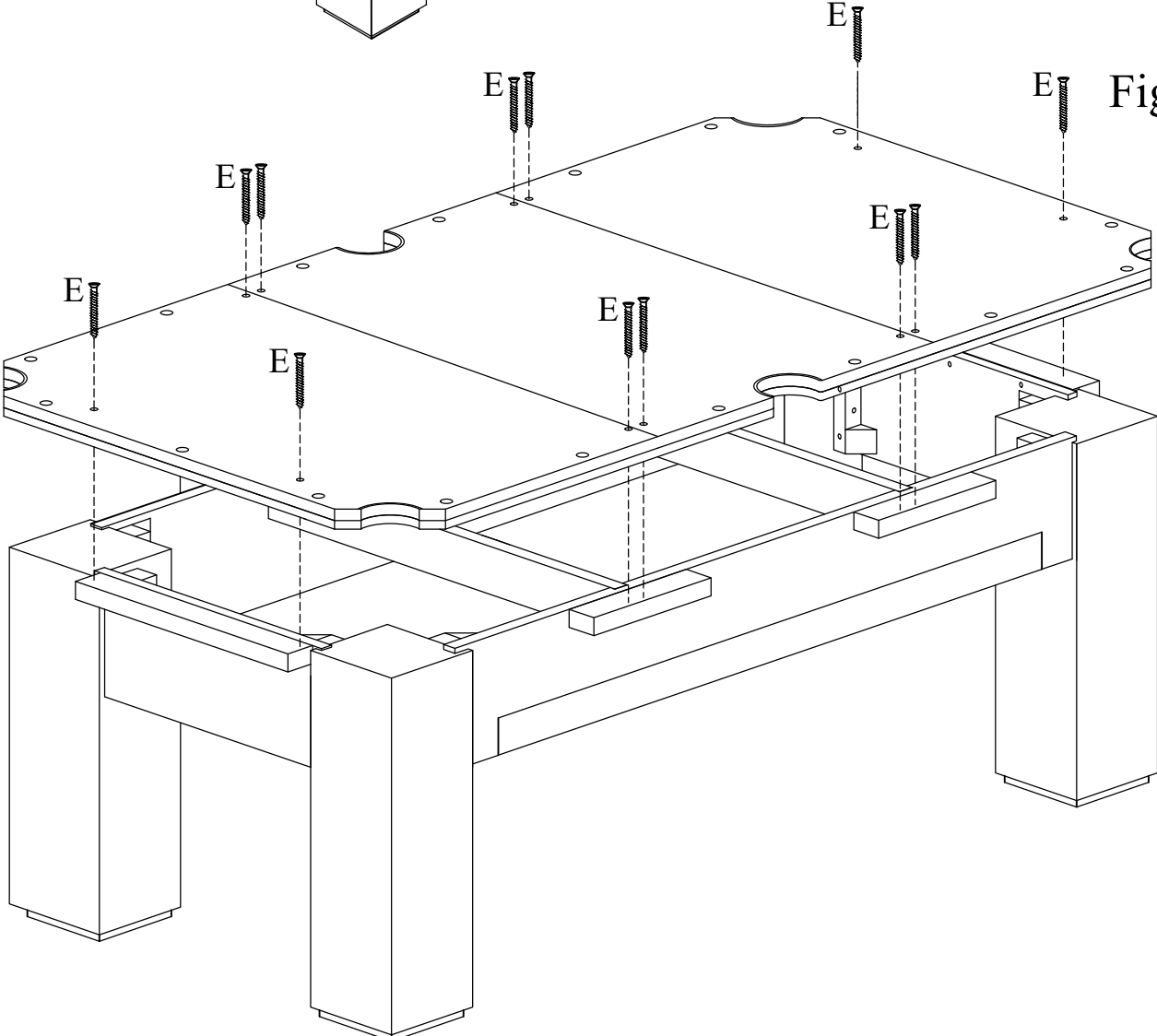


Fig.5

